



Sovitron Interior Pvt.Ltd.



Model Name	JETT-2003B/DL-OYS-2003B-10
Description	Bollard light

Technical description	Image
-----------------------	-------

Dimension	Dia=160mm H=As per requirement
Frame	Aluminium Die-cast
Color Tempertaure	3000K
Power	10W
Total Luminous Flux	800 lm
Efficacy	80 lm/W
IP rating	65
Color Rendering	≥80
Mounting	Surface
Optics	Clear polycarbonate diffuser
Dimming	NON-Dimmable
Operating Voltage	220-240 VAC
Standard Lifetime	L70 minimum at 50,000 burning hours



Dimension diagram

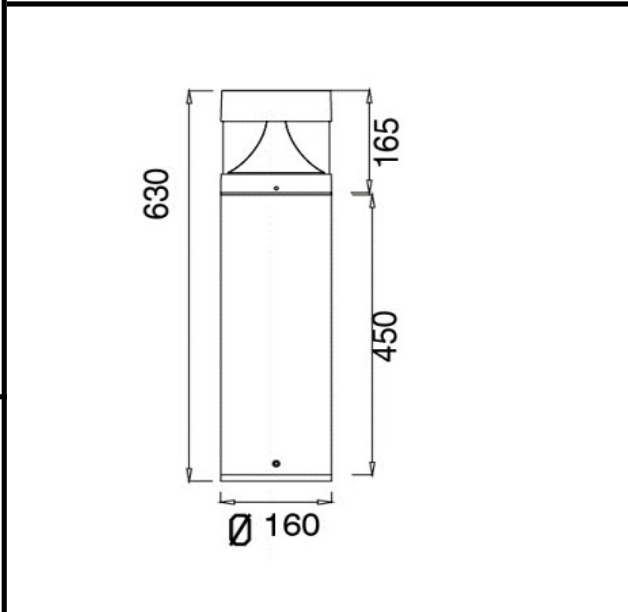

Remarks:-

Address: Plot #7 Saroorpur-Nangla Industrial Area,Ballabgharh-Sohna Road,Faridabad-121005
Email: info@sovitron.com